

Typical Performance

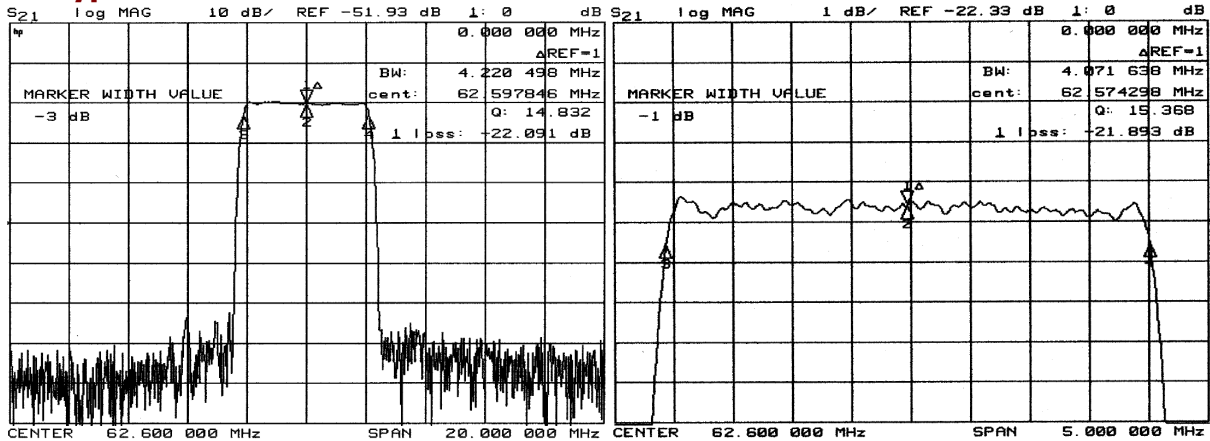

Specification

Index	Unit	Min	Typical	Max
Center Frequency	MHz	62.52	62.60	62.68
Insertion Loss	dB	-	22.0	24.0
1 dB Bandwidth	MHz	4.00	4.07	-
3 dB Bandwidth	MHz	4.20	4.22	-
40 dB Bandwidth	MHz	-	4.86	5.00
Passband Ripple	dB	-	0.65	1.00
Group Delay Variation	nsec	-	200	300
Absolute Delay	µsec	-	4.50	-
Ultimate Rejection	dB	50	55	-
Substrate Material	-	YZ-LiNbO3		
Temperature Coefficient	ppm/°C	-94		
Package	mm	35		

Package Dimension

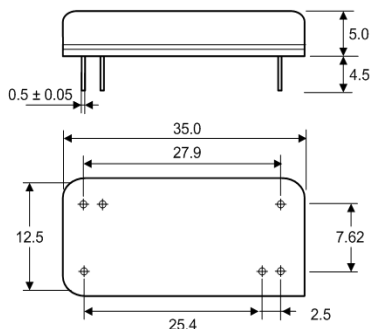

Matching Configuration

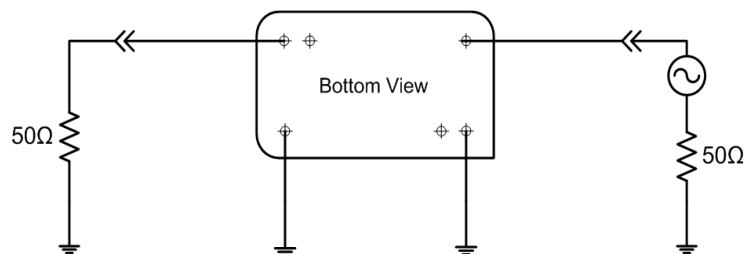

No matching required
Source / Load Impedance = 50Ω
Ambient Temperature = 25°C