

Typical Performance

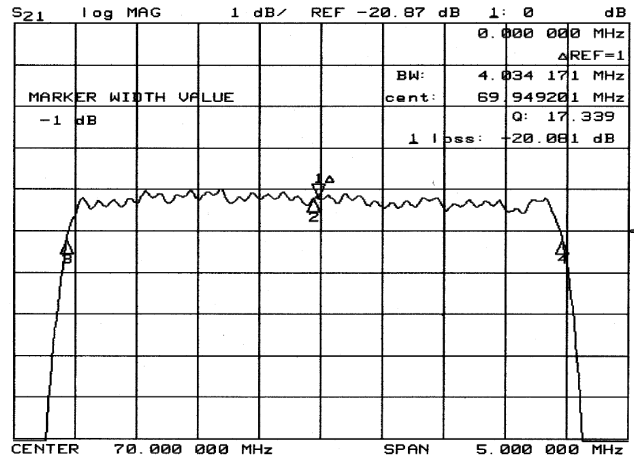
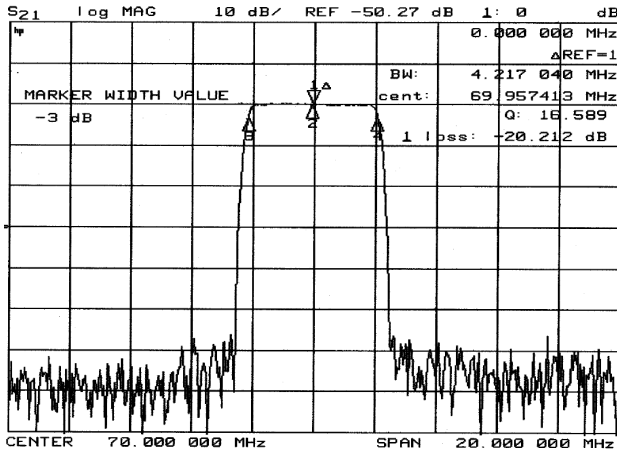

Specification

Index	Unit	Min	Typical	Max
Center Frequency	MHz	69.92	70.00	70.08
Insertion Loss	dB	-	20.5	22.0
1 dB Bandwidth	MHz	3.80	4.05	-
3 dB Bandwidth	MHz	4.00	4.20	-
40 dB Bandwidth	MHz	-	5.00	5.20
Passband Ripple	dB	-	0.55	1.00
Group Delay Variation	nsec	-	200	300
Absolute Delay	µsec	-	4.00	-
Ultimate Rejection	dB	50	60	-
Substrate Material	-	YZ-LiNbO3		
Temperature Coefficient	ppm/°C	-94		
Package	mm	35		

Package Dimension

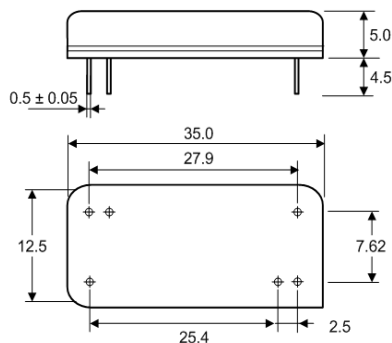

Matching Configuration

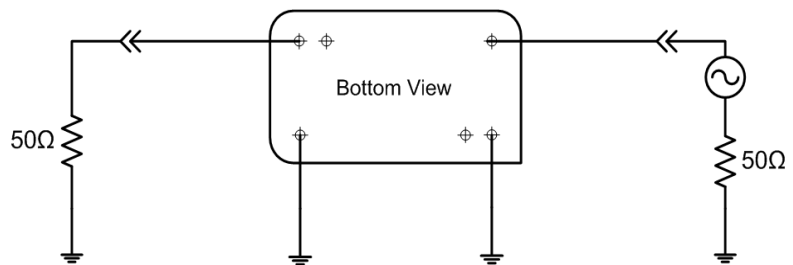

No matching required
 Source / Load Impedance = 50Ω
 Ambient Temperature = 25°C