

Typical Performance

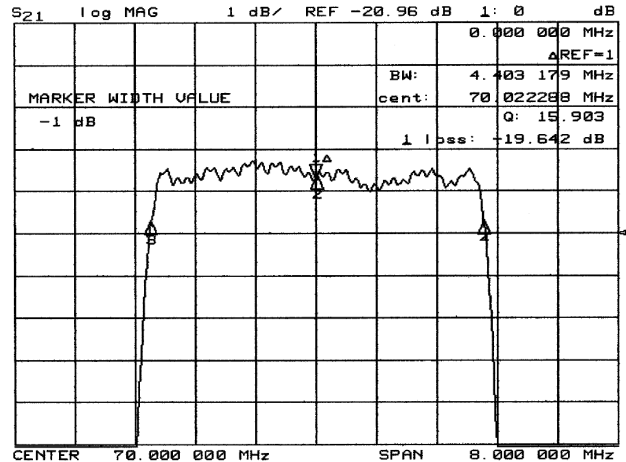
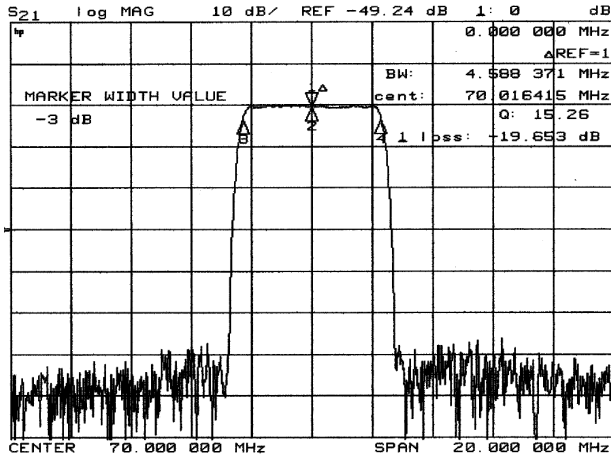

Specification

Index	Unit	Min	Typical	Max
Center Frequency	MHz	69.92	70.00	70.08
Insertion Loss	dB	-	20.0	23.0
1 dB Bandwidth	MHz	4.20	4.40	-
3 dB Bandwidth	MHz	4.40	4.58	-
40 dB Bandwidth	MHz	-	5.38	5.60
Passband Ripple	dB	-	0.75	1.00
Group Delay Variation	nsec	-	150	300
Absolute Delay	µsec	-	4.00	-
Ultimate Rejection	dB	50	60	-
Substrate Material	-	YZ-LiNbO3		
Temperature Coefficient	ppm/°C	-72		
Package	mm	35		

Package Dimension

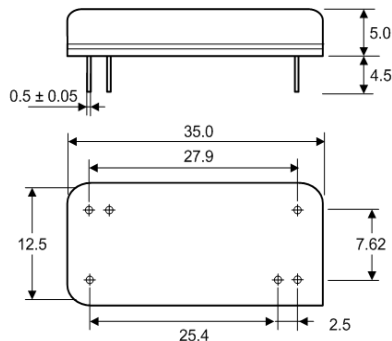

Matching Configuration

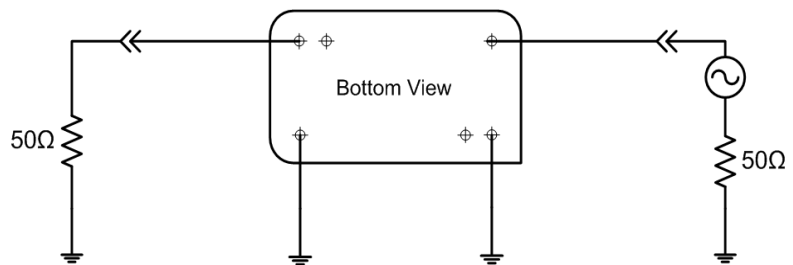

No matching required
 Source / Load Impedance = 50Ω
 Ambient Temperature = 25°C