

Typical Performance

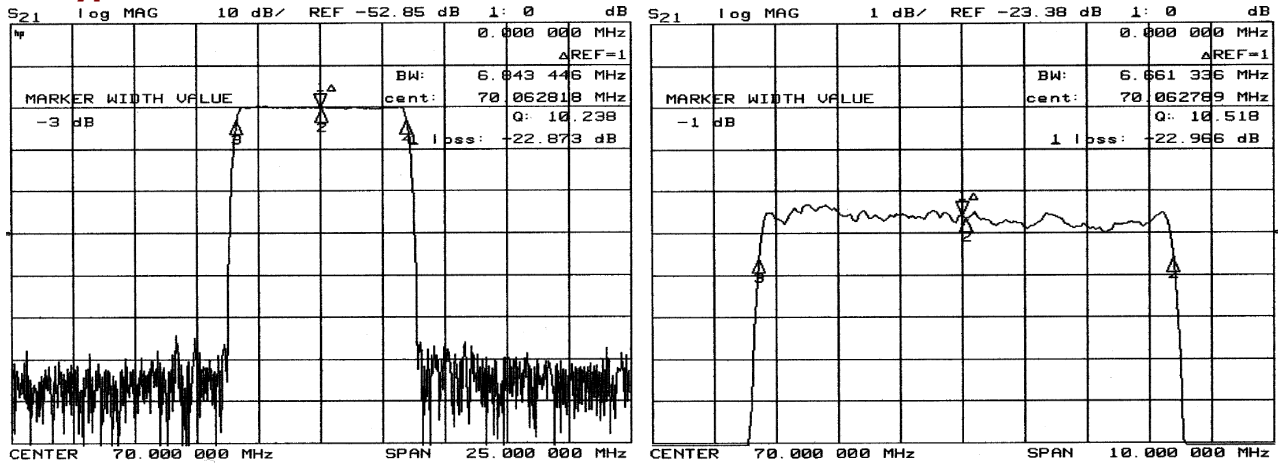

Specification

Index	Unit	Min	Typical	Max
Center Frequency	MHz	69.92	70.00	70.08
Insertion Loss	dB	-	23.0	24.5
1 dB Bandwidth	MHz	6.50	6.66	-
3 dB Bandwidth	MHz	6.70	6.84	-
40 dB Bandwidth	MHz	-	7.61	7.80
Passband Ripple	dB	-	0.75	1.00
Group Delay Variation	nsec	-	100	200
Absolute Delay	µsec	-	4.00	-
Ultimate Rejection	dB	50	60	-
Substrate Material	-	YZ-LiNbO3		
Temperature Coefficient	ppm/°C	-94		
Package	mm	35		

Package Dimension

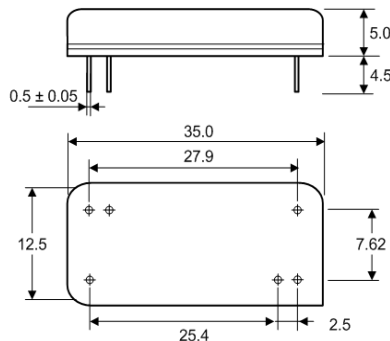

Matching Configuration

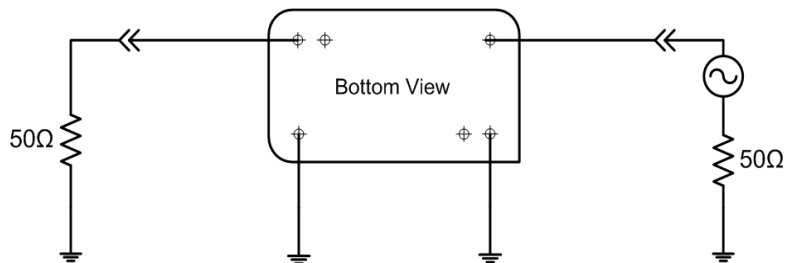

No matching required
Source / Load Impedance = 50Ω
Ambient Temperature = 25°C