

Typical Performance

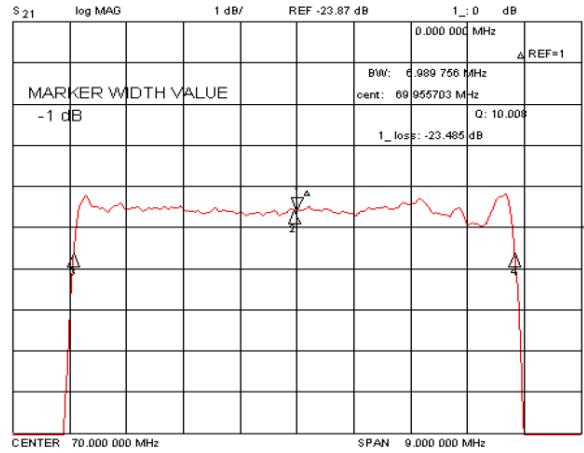
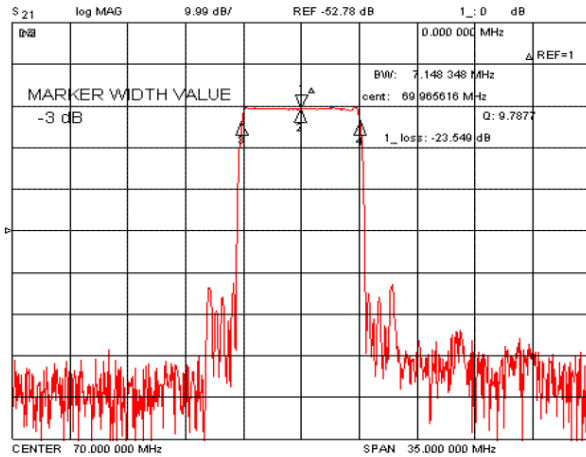

Specification

Index	Unit	Min	Typical	Max
Center Frequency	MHz	69.96	70.00	70.04
Insertion Loss	dB	-	23.5	25.0
1 dB Bandwidth	MHz	6.96	6.98	-
3 dB Bandwidth	MHz	-	7.14	-
40 dB Bandwidth	MHz	-	7.80	7.82
Passband Ripple	dB	-	0.75	1.00
Group Delay Variation	nsec	-	110	200
Absolute Delay	µsec	-	3.68	-
Ultimate Rejection	dB	-	45	-
Package	mm ²	34.7 x 12.6		
Substrate Material		YZ-LiNbO ₃		
Temperature Coefficient	ppm/°C	-94		

Package Dimension

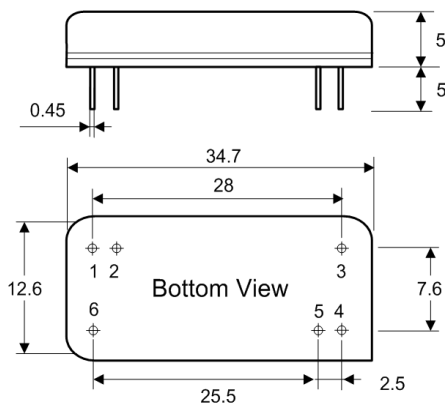

Matching Configuration

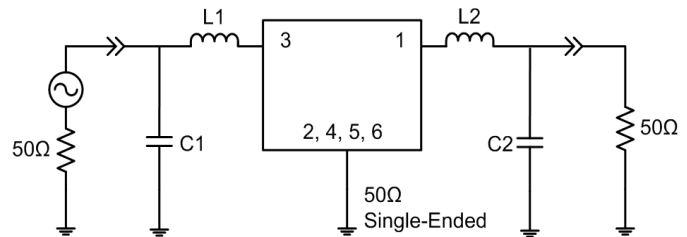

L1=82nH, L2=82nH, C1=24pF, C2=24pF
Source / Load Impedance = 50Ω
Ambient Temperature = 25°C